

# Domestic Power Supply Cords, 3 Conductor, PVC Jacket, UL, CSA

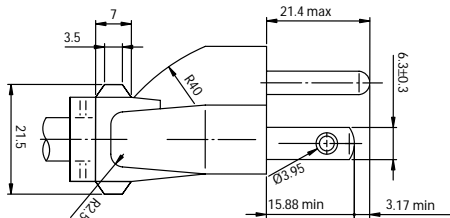

## Nondetachable with NEMA 5-15P



Part No.	Cord Length		Conductor		Nominal O.D.		Power Rating	Cord Type / Temp	Plug No.			Jacket Color
	Ft	M	AWG.	Strand	Inch	mm			Male	Fem.	Color Code	

## Dual Shielded

IPC-64021A	6'7"	2	18	41 x 34	.280	7.1	1250 Watts 10A @ 125V	SVT/Shield Foil and Braid / 60°C	LP-31	---	NA	Black
IPC-64022A	9'10"	3	18	41 x 34	.280	7.1	1250 Watts 10A @ 125V	SVT/Shield Foil and Braid / 60°C	LP-31	---	NA	Black

## Aluminum Foil Shielded

IPC-64001A	6'7"	2	18	41 x 34	.260	6.6	1250 Watts 10A @ 125V	SVT/Alum. Foil Shield / 60°C	LP-31	---	NA	Black
IPC-64002A	9'10"	3	18	41 x 34	.260	6.6	1250 Watts 10A @ 125V	SVT/Alum. Foil Shield / 60°C	LP-31	---	NA	Black
IPC-64012A	6'7"	2	18	41 x 34	.330	8.4	1250 Watts 10A @ 125V	SJT/Alum. Foil Shield / 60°C	LP-31	---	NA	Black
IPC-64003A	9'10"	3	18	41 x 34	.330	8.4	1250 Watts 10A @ 125V	SJT/Alum. Foil Shield / 60°C	LP-31	---	NA	Black

## Aluminum Foil Shielded, 105°C VW-1 Jacket

IPC-64025A	6'7"	2	18	41 x 34	.260	6.6	1250 Watts 10A @ 125V	SVT/Alum. Foil Shield / 105°C	LP-31	---	NA	Black
IPC-64026A	6'7"	2	18	41 x 34	.260	6.6	1250 Watts 10A @ 125V	SJT/Alum. Foil Shield / 105°C	LP-31	---	NA	Black

## Unshielded 105°C VW-1 Jacket

IPC-65050A	6'7"	2	18	41 x 34	.245	6.2	1250 Watts 10A @ 125V	SVT / 105°C	LP-30	---	NA	Black
IPC-65051A	6'7"	2	18	41 x 34	.315	8.0	1250 Watts 10A @ 125V	SJT / 105°C	LP-30	---	NA	Black

## Unshielded

IPC-65001A	6'7"	2	18	41 x 34	.245	6.2	1250 Watts 10A @ 125V	SVT / 60°C	LP-30	---	NA	Black
IPC-65002A	9'10"	3	18	41 x 34	.245	6.2	1250 Watts 10A @ 125V	SVT / 60°C	LP-30	---	NA	Black
IPC-65019A	6'7"	2	18	41 x 34	.315	8.0	1250 Watts 10A @ 125V	SJT / 60°C	LP-30	---	NA	Black
IPC-65003A	9'10"	3	18	41 x 34	.315	8.0	1250 Watts 10A @ 125V	SJT / 60°C	LP-30	---	NA	Black
IPC-65015AGY	6	1.83	18	41 x 34	.245	6.2	1250 Watts 10A @ 125V	SVT / 60°C	LP-30	---	NA	Grey
IPC-65021AGY	8'	2.44	18	41 x 34	.245	6.2	1250 Watts 10A @ 125V	SVT / 60°C	LP-30	---	NA	Grey
IPC-65029A	6'7"	2	16	67 x 34	.335	8.5	1625 Watts 13A @ 125V	SJT / 60°C	LP-31	---	NA	Black
IPC-65030A	9'10"	3	16	67 x 34	.335	8.5	1625 Watts 13A @ 125V	SJT / 60°C	LP-31	---	NA	Black
IPC-65031A	6'7"	2	14	41 x 30	.380	9.7	1875 Watts 15A @ 125V	SJT / 60°C	LP-31	---	NA	Black
IPC-65032A	9'10"	3	14	41 x 30	.380	9.7	1875 Watts 15A @ 125V	SJT / 60°C	LP-31	---	NA	Black



Call Toll Free: 1-800-341-3533

Telephone: (952) 835-2322

Fax: (952) 835-5080

# Domestic Power Supply Cords

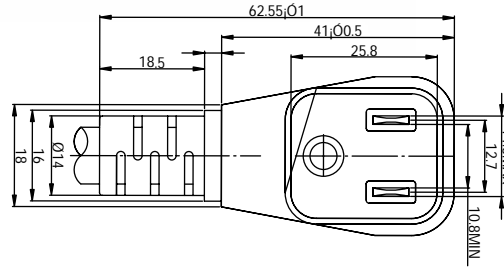

## Nondetachable with NEMA 5-15P Right Angle Plug

Jacket removed 2", conductors stripped 5/8"



Part No.	Cord Length		Conductor		Nominal O.D.		Power Rating	Cord Type / Temp	Plug No.		Color Code	Jacket Color
	Ft	M	AWG.	Stranding	Inch	mm			Male	Fem.		
IPC-65137A	6'7"	2	18 / 41x34		.245	6.2	10A @ 125V	SVT 60°C	LP-31L	---	NA	Black
IPC-65138A	8'2"	2.5	18 / 41x34		.245	6.2	10A @ 125V	SVT 60°C	LP-31L	---	NA	Black
IPC-65139A	6'7"	2	18 / 41x34		.315	8.0	10A @ 125V	SJT 60°C	LP-31L	---	NA	Black
IPC-65140A	8'2"	2.5	18 / 41x34		.315	8.0	10A @ 125V	SJT 60°C	LP-31L	---	NA	Black
IPC-65141A	6'7"	2	16 / 41x34		.335	8.5	13A @ 125V	SJT 60°C	LP-31L	---	NA	Black
IPC-65142A	8'2"	2.5	16 / 41x34		.335	8.5	13A @ 125V	SJT 60°C	LP-31L	---	NA	Black
IPC-65143A	6'7"	2	14 / 41x34		.38	9.7	15A @ 125V	SJT 60°C	LP-31L	---	NA	Black
IPC-65144A	8'2"	2.5	14 / 41x34		.38	9.7	15A @ 125V	SJT 60°C	LP-31L	---	NA	Black

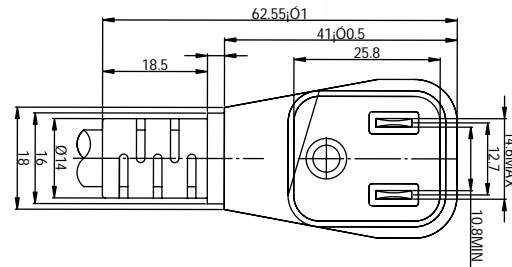

Items also available but not pictured include:  
Multi-Directional plug 5/15P in 45°,  
60°, 90°, 120° and 180° versions  
Please consult factory for availability

## Nondetachable with NEMA 5-15P Right Angle Plug

Conductors split 1 1/2", stripped 5/8"



Part No.	Cord Length		Conductor		Nominal O.D.		Power Rating	Cord Type / Temp	Plug No.		Color Code	Jacket Color
	Ft	M	AWG.	Strand	Inch	mm			Male	Fem.		
IPC-65090A	4'	1.22	18	41 x 34	.145 x .339	3.7 x 8.6	1250 Watts 10A @ 125V	SPT-2 / 60°C	LP-31L	---	NA	Black
IPC-65091A	6'	1.83	18	41 x 34	.145 x .339	3.7 x 8.6	1250 Watts 10A @ 125V	SPT-2 / 60°C	LP-31L	---	NA	Black
IPC-65092A	8'	2.44	18	41 x 34	.145 x .339	3.7 x 8.6	1250 Watts 10A @ 125V	SPT-2 / 60°C	LP-31L	---	NA	Black
IPC-65093A	4'	1.22	18	41 x 34	.181 x .390	4.6 x 9.9	1250 Watts 10A @ 125V	SPT-3 / 60°C	LP-31L	---	NA	Black
IPC-65094A	6'	1.83	18	41 x 34	.181 x .390	4.6 x 9.9	1250 Watts 10A @ 125V	SPT-3 / 60°C	LP-31L	---	NA	Black
IPC-65095A	8'	2.44	18	41 x 34	.181 x .390	4.6 x 9.9	1250 Watts 10A @ 125V	SPT-3 / 60°C	LP-31L	---	NA	Black
IPC-65096A	4'	1.22	16	67 x 34	.157 x .362	4.0 x 9.2	1625 Watts 13A @ 125V	SPT-2 / 60°C	LP-31L	---	NA	Black
IPC-65097A	6'	1.83	16	67 x 34	.157 x .362	4.0 x 9.2	1625 Watts 13A @ 125V	SPT-2 / 60°C	LP-31L	---	NA	Black
IPC-65098A	8'	2.44	16	67 x 34	.157 x .362	4.0 x 9.2	1625 Watts 13A @ 125V	SPT-2 / 60°C	LP-31L	---	NA	Black
IPC-65099A	4'	1.22	16	67 x 34	.181 x .445	4.6 x 11.3	1625 Watts 13A @ 125V	SPT-3 / 60°C	LP-31L	---	NA	Black
IPC-65100A	6'	1.83	16	67 x 34	.181 x .445	4.6 x 11.3	1625 Watts 13A @ 125V	SPT-3 / 60°C	LP-31L	---	NA	Black
IPC-65101A	8'	2.44	16	67 x 34	.181 x .445	4.6 x 11.3	1625 Watts 13A @ 125V	SPT-3 / 60°C	LP-31L	---	NA	Black



Call Toll Free: 1-800-341-3533

Telephone: (952) 835-2322

Fax: (952) 835-5080

# Domestic Power Supply Cords, 3 Conductor

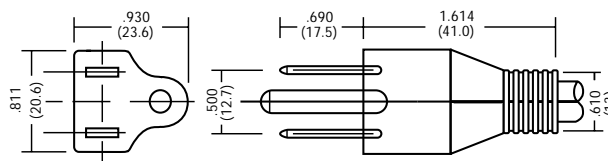

## Nondetachable with Straight 5/15P Plug

Conductors split 1 1/2", stripped 5/8"



Part No.	Cord Length		Conductor		Nominal O.D.		Power Rating	Cord Type / Temp	Plug No.		Color Code	Jacket Color
	Ft	M	AWG.	Strand	Inch	mm			Male	Fem.		
IPC-65075A	4'	1.22	18	41 x 34	.110 x .307	2.8 x 7.8	1250 Watts 10A @ 125V	SPT-1 / 60°C	LP-30	---	NA	Black
IPC-65076A	6'	1.83	18	41 x 34	.110 x .307	2.8 x 7.8	1250 Watts 10A @ 125V	SPT-1 / 60°C	LP-30	---	NA	Black
IPC-65077A	8'	2.44	18	41 x 34	.110 x .307	2.8 x 7.8	1250 Watts 10A @ 125V	SPT-1 / 60°C	LP-30	---	NA	Black
IPC-65078A	4'	1.22	18	41 x 34	.145 x .339	3.7 x 8.6	1250 Watts 10A @ 125V	SPT-2 / 60°C	LP-30	---	NA	Black
IPC-65079A	6'	1.83	18	41 x 34	.145 x .339	3.7 x 8.6	1250 Watts 10A @ 125V	SPT-2 / 60°C	LP-30	---	NA	Black
IPC-65080A	8'	2.44	18	41 x 34	.145 x .339	3.7 x 8.6	1250 Watts 10A @ 125V	SPT-2 / 60°C	LP-30	---	NA	Black
IPC-65081A	4'	1.22	18	41 x 34	.181 x .390	4.6 x 9.9	1250 Watts 10A @ 125V	SPT-3 / 60°C	LP-31	---	NA	Black
IPC-65082A	6'	1.83	18	41 x 34	.181 x .390	4.6 x 9.9	1250 Watts 10A @ 125V	SPT-3 / 60°C	LP-31	---	NA	Black
IPC-65083A	8'	2.44	18	41 x 34	.181 x .390	4.6 x 9.9	1250 Watts 10A @ 125V	SPT-3 / 60°C	LP-31	---	NA	Black
IPC-65084A	4'	1.22	16	67 x 34	.157 x .362	4.0 x 9.2	1625 Watts 13A @ 125V	SPT-2 / 60°C	LP-31	---	NA	Black
IPC-65085A	6'	1.83	16	67 x 34	.157 x .362	4.0 x 9.2	1625 Watts 13A @ 125V	SPT-2 / 60°C	LP-31	---	NA	Black
IPC-65086A	8'	2.44	16	67 x 34	.157 x .362	4.0 x 9.2	1625 Watts 13A @ 125V	SPT-2 / 60°C	LP-31	---	NA	Black
IPC-65087A	4'	1.22	16	67 x 34	.181 x .445	4.6 x 11.3	1625 Watts 13A @ 125V	SPT-3 / 60°C	LP-31	---	NA	Black
IPC-65088A	6'	1.83	16	67 x 34	.181 x .445	4.6 x 11.3	1625 Watts 13A @ 125V	SPT-3 / 60°C	LP-31	---	NA	Black
IPC-65089A	8'	2.44	16	67 x 34	.181 x .445	4.6 x 11.3	1625 Watts 13A @ 125V	SPT-3 / 60°C	LP-31	---	NA	Black
IPC-65103A	8'	2.44	18	41 x 34	.140 x .325	3.6 x 8.3	1250 Watts 10A @ 125V	HPN-3 / 105°C	LP-31	---	NA	Black
IPC-65104A	8'	2.44	16	67 x 34	.160 x .365	4.1 x 9.3	1625 Watts 13A @ 125V	HPN-3 / 105°C	LP-31	---	NA	Black

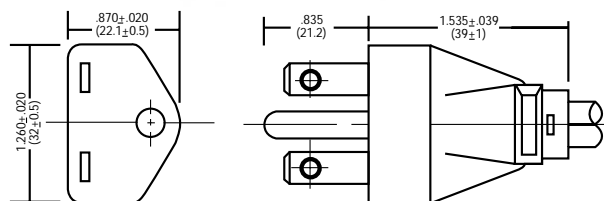

## Unshielded Nondetachable with NEMA 6-15P, Plug 250V

Outer Jacket removed 2", conductors stripped 5/8"



Part No.	Cord Length	Conductor	Nominal O.D.	Power Rating	Cord Type / Temp	Plug No.	Color Code	Jacket Color				
	Ft	AWG.	Strand	Inch	mm	Male	Fem.					
IPC-65044A	67"	2	18	41 x 34	.245	6.2	1500 Watts 6A @ 250V	SVT / 60°C	LP-35	---	NA	Black
IPC-65045A	9'10"	3	18	41 x 34	.245	6.2	1500 Watts 6A @ 250V	SVT / 60°C	LP-35	---	NA	Black
IPC-65046A	67"	2	18	41 x 34	.315	8.0	1500 Watts 6A @ 250V	SJT / 60°C	LP-35	---	NA	Black
IPC-65047A	9'10"	3	18	41 x 34	.315	8.0	1500 Watts 6A @ 250V	SJT / 60°C	LP-35	---	NA	Black
IPC-65105A	67"	2	16	67 x 34	.181 x .445	4.6 x 11.3	1625 Watts 13A @ 250V	SPT-3 / 60°C	LP-35	---	NA	Black
IPC-65106A	9'10"	3	16	65 x 34	.335	8.5	1625 Watts 13A @ 250V	SJT / 60°C	LP-35	---	NA	Black
IPC-65107A	9'10"	3	14	41 x 30	.380	9.7	1875 Watts 13A @ 250V	SJT / 60°C	LP-35	---	NA	Black



# Domestic Cordsets, 3 Conductor, Detachable

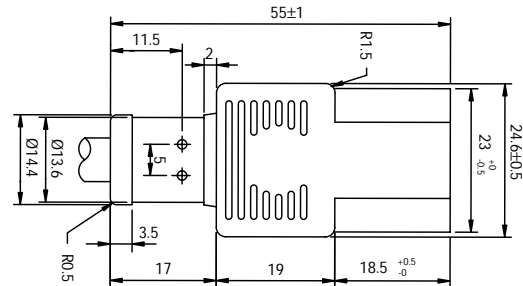
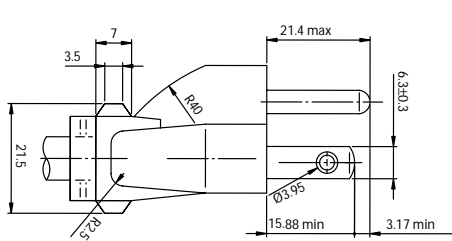

## Detachable with an IEC-320-C13



Part No.	Cord Length		Conductor		Nominal O.D.		Power Rating	Cord Type / Temp	Plug No.			
	Ft	M	AWG.	Strand	Inch	mm			Male	Fem.	Color Code	Jacket Color

## Dual Shielded

IPC-64023A	6'7"	2	18	41 x 34	.280	7.1	1250 Watts 10A @ 125V	SVT/Alum. Foil Shield / 60°C	LP-31	LS-13	NA	Black
IPC-64024A	9'10"	3	18	41 x 34	.280	7.1	1250 Watts 10A @ 125V	SVT/Alum. Foil Shield / 60°C	LP-31	LS-13	NA	Black

## Aluminum Foil Shielded, 105° C VW-1 Jacket

IPC-64027A	6'7"	2	18	41 x 34	.260	6.6	1250 Watts 10A @ 125V	SVT/Alum. Foil Shield / 105°C	LP-31	LS-13	NA	Black
IPC-64028A	9'10"	2	18	41 x 34	.330	8.4	1250 Watts 10A @ 125V	SJT/Alum. Foil Shield / 105°C	LP-31	LS-13	NA	Black

## Aluminum Foil Shielded

IPC-64007A	6'7"	2	18	41 x 34	.260	6.6	1250 Watts 10A @ 125V	SVT/Alum. Foil Shield / 60°C	LP-31	LS-13	NA	Black
IPC-64008A	9'10"	3	18	41 x 34	.260	6.6	1250 Watts 10A @ 125V	SVT/Alum. Foil Shield / 60°C	LP-31	LS-13	NA	Black
IPC-64009A	6'7"	2	18	41 x 34	.330	8.4	1250 Watts 10A @ 125V	SJT/Alum. Foil Shield / 60°C	LP-31	LS-13	NA	Black
IPC-64014A	9'10"	3	18	41 x 34	.330	8.4	1250 Watts 10A @ 125V	SJT/Alum. Foil Shield / 60°C	LP-31	LS-13	NA	Black

## Unshielded, 105° C VW-1 Jacket

IPC-65052A	7'6"	2.29	18	41 x 34	.245	6.2	1250 Watts 10A @ 125V	SVT / 105°C	LP-30	LS-13	NA	Black
IPC-65053A	6'7"	2	18	41 x 34	.315	8.0	1250 Watts 10A @ 125V	SJT / 105°C	LP-31	LS-13	NA	Black

## Unshielded

IPC-65010B-00	6'	1.83	18	41 x 34	.245	6.2	1250 Watts 10A @ 125V	SVT / 60°C	LP-30	LS-13	NA	Black
IPC-65010B-01	7'6"	2.29	18	41 x 34	.245	6.2	1250 Watts 10A @ 125V	SVT / 60°C	LP-30	LS-13	NA	Black
IPC-65010B-03	9'10"	3	18	41 x 34	.245	6.2	1250 Watts 10A @ 125V	SVT / 60°C	LP-30	LS-13	NA	Black
IPC-65008A	6'7"	2	18	41 x 34	.315	8.0	1250 Watts 10A @ 125V	SJT / 60°C	LP-31	LS-13	NA	Black
IPC-65009A	9'10"	3	18	41 x 34	.315	8.0	1250 Watts 10A @ 125V	SJT / 60°C	LP-31	LS-13	NA	Black
IPC-65027A	6'7"	2	16	65 x 34	.335	8.5	1625 Watts 13A @ 125V	SJT / 60°C	LP-31	LS-13	NA	Black
IPC-65017A	7'6"	2.29	16	65 x 34	.335	8.5	1625 Watts 13A @ 125V	SJT / 60°C	LP-31	LS-13	NA	Black
IPC-65028A	9'10"	3	16	65 x 34	.335	8.5	1625 Watts 13A @ 125V	SJT / 60°C	LP-31	LS-13	NA	Black
IPC-65112A	6'7"	2	14	41 x 30	.38	9.7	1875 Watts 15A @ 125 V	SJT / 60°C	LP-31	LS-13	NA	Black
IPC-65113A	8'2"	2.5	14	41 x 30	.38	9.7	1875 Watts 15A @ 125 V	SJT / 60°C	LP-31	LS-13	NA	Black

# Domestic Cordsets, 3 Conductor, Detachable

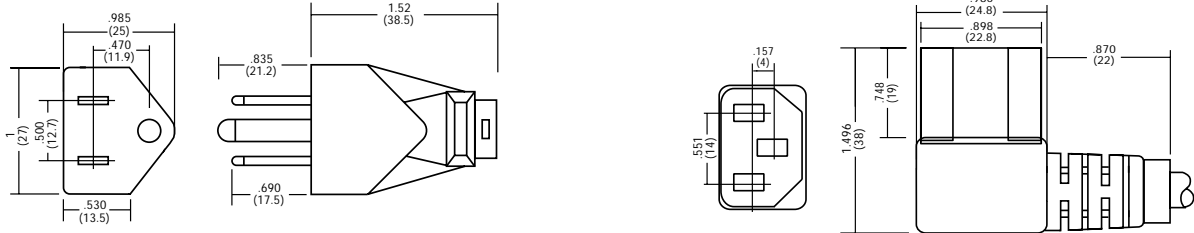

## Detachable with an IEC-320-C13 Right Angle



Part No.	Cord Length		Conductor AWG. Strand	Nominal O.D.		Power Rating	Cord Type / Temp	Plug No.		
	Ft	M		Inch	mm			Male	Fem.	Color Code

## Foil Shielded

IPC-64010A	6'7"	2	18 41 x 34	.260	6.6	1250 Watts 10A @ 125V	SVT/Alum. Foil Shield / 60°C	LP-31	LS-13L	NA	Black
IPC-64015A	9'10"	3	18 41 x 34	.260	6.6	1250 Watts 10A @ 125V	SVT/Alum. Foil Shield / 60°C	LP-31	LS-13L	NA	Black
IPC-64016A	6'7"	2	18 41 x 34	.330	8.4	1250 Watts 10A @ 125V	SJT/Alum. Foil Shield / 60°C	LP-31	LS-13L	NA	Black
IPC-64017A	9'10"	3	18 41 x 34	.330	8.4	1250 Watts 10A @ 125V	SJT/Alum. Foil Shield / 60°C	LP-31	LS-13L	NA	Black

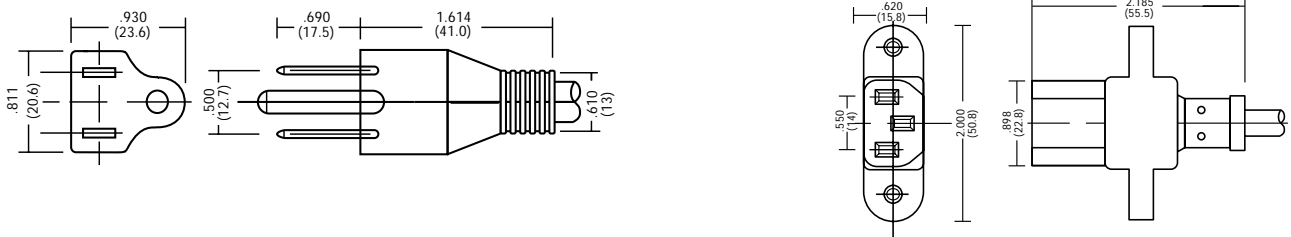

## Detachable with an IEC-320, C13 with Mounting Ears



Part No.	Cord Length		Conductor AWG. Strand	Nominal O.D.		Power Rating	Cord Type / Temp	Plug No.		
	Ft	M		Inch	mm			Male	Fem.	Color Code

## Unshielded

IPC-65054A	6'7"	2	18 41 x 34	.245	6.2	1250 Watts 10A @ 125V	SVT / 60°C	LP-30	LS-13SA	NA	Black
IPC-65055A	7'6"	2.29	18 41 x 34	.245	6.2	1250 Watts 10A @ 125V	SVT / 60°C	LP-30	LS-13SA	NA	Black
IPC-65056A	9'10"	3	18 41 x 34	.245	6.2	1250 Watts 10A @ 125V	SVT / 60°C	LP-30	LS-13SA	NA	Black
IPC-65057A	6'7"	2	18 41 x 34	.315	8.0	1250 Watts 10A @ 125V	SJT / 60°C	LP-31	LS-13SA	NA	Black
IPC-65058A	9'10"	3	18 41 x 34	.315	8.0	1250 Watts 10A @ 125V	SJT / 60°C	LP-31	LS-13SA	NA	Black



Call Toll Free: 1-800-341-3533

Telephone: (952) 835-2322

Fax: (952) 835-5080



# Domestic Cordsets, 3 Conductor, Detachable

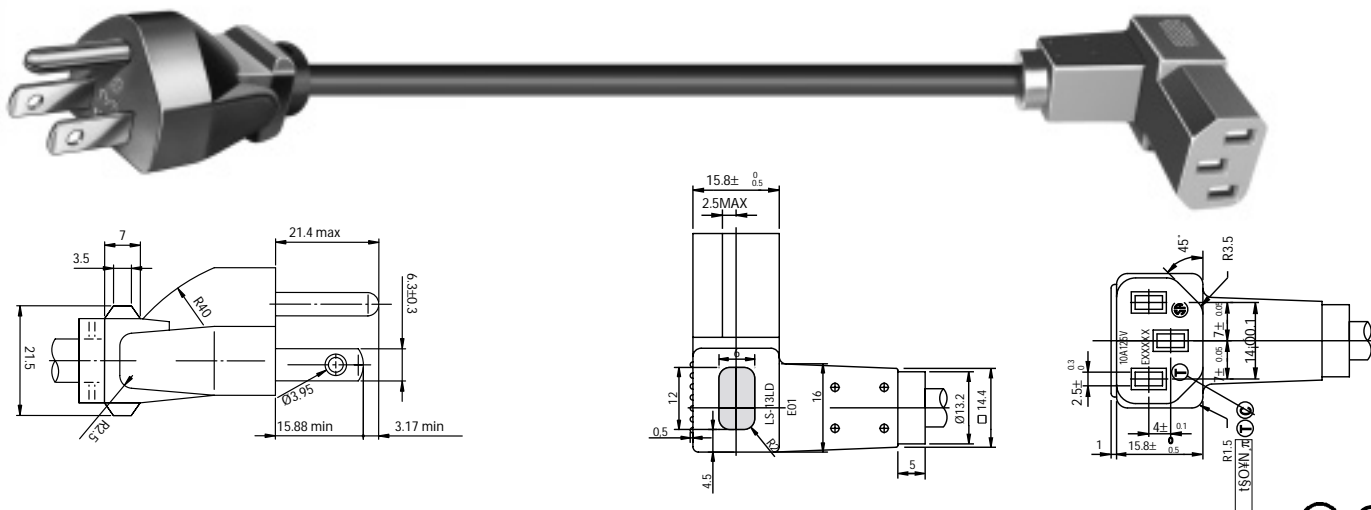

## Detachable with a Down Angle IEC-320-C13

Part No.	Cord Length		Conductor Awg	Nominal O.D.		Power Rating	Cord Type / Temp	Plug No.		Color Code	Jacket Color
	Ft	M		Inch	mm			Male	Fem		
<b>Unshielded</b>											
IPC-65146A	6'7"	2	18/3	.315	8.0	10A @ 125V	SJT / 60°C	LP-31	LS-13LD	Black	NA
IPC-65147A	8'2"	2.5	18/3	.315	8.0	10A @ 125V	SJT / 60°C	LP-31	LS-13LD	Black	NA
IPC-65150A	6'7"	2	16/3	.335	8.5	13A @ 125V	SJT / 60°C	LP-31	LS-13LD	Black	NA
IPC-65151A	8'2"	2.5	16/3	.335	8.5	13A @ 125V	SJT / 60°C	LP-31	LS-13LD	Black	NA

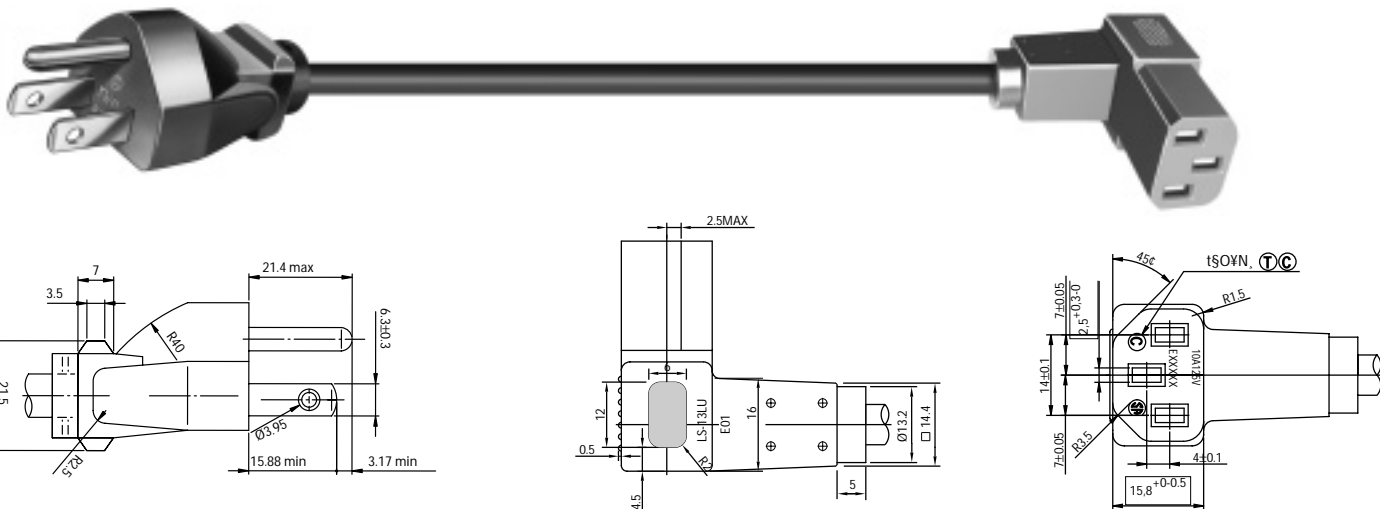

## Detachable with an Up Angle IEC-320-C13

Part No.	Cord Length		Conductor Awg	Nominal O.D.		Power Rating	Cord Type / Temp	Plug No.		Color Code	Jacket Color
	Ft	M		Inch	mm			Male	Fem		
<b>Unshielded</b>											
IPC-65152A	6'7"	2	18/3	.315	8.0	10A @ 125V	SJT / 60°C	LP-31	LS-13LU	Black	NA
IPC-65153A	8'2"	2.5	18/3	.315	8.0	10A @ 125V	SJT / 60°C	LP-31	LS-13LU	Black	NA
IPC-65156A	6'7"	2	16/3	.335	8.5	13A @ 125V	SJT / 60°C	LP-31	LS-13LU	Black	NA
IPC-65157A	8'2"	2.5	16/3	.335	8.5	13A @ 125V	SJT / 60°C	LP-31	LS-13LU	Black	NA







# Domestic Jumper Cords, 3 Conductor Detachable

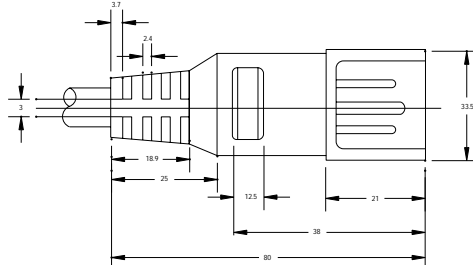
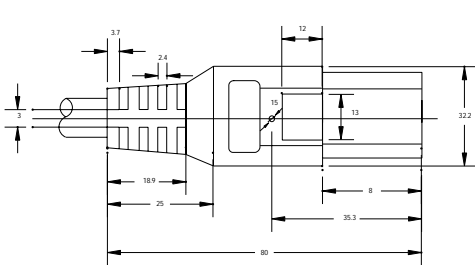

## Detachable with an IEC-320-C19 to C20, 15 Amp



Part No.	Cord Length		Conductor		Nominal O.D.		Power Rating	Cord Type / Temp	Plug No.		Color Code	Jacket Color
	Ft	M	AWG.	Strand	Inch	mm			Male	Fem.		
IPC-65127A	6'7"	2	14	41x30	.38	9.7	15A @ 125 V	SJT / 60°C	EN60320-2-2I	EN60320	NA	Black
IPC-65128A	8'2"	2.5	14	41x30	.38	9.7	15A @ 125 V	SJT / 60°C	EN60320-2-2I	EN60320	NA	Black
IPC-65129A	9'10"	3	14	41x30	.38	9.7	15A @ 125 V	SJT / 60°C	EN60320-2-2I	EN60320	NA	Black

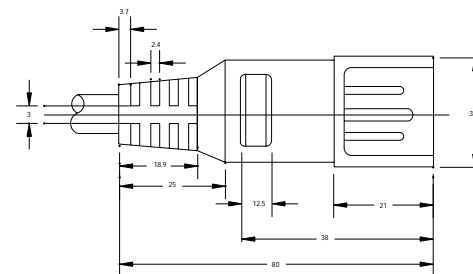
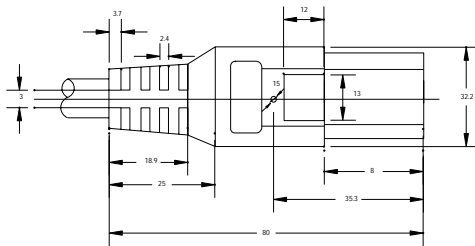

## Detachable with an IEC-320-C19 to C20, 20 Amp



Part No.	Cord Length		Conductor		Nominal O.D.		Power Rating	Cord Type / Temp	Plug No.		Color Code	Jacket Color
	Ft	M	AWG.	Strand	Inch	mm			Male	Fem.		
IPC-65130A	6'7"	2	12	48x30	.43	10.9	20A @ 125 V	SJT / 60°C	EN60320-2-2I	EN60320	NA	Black
IPC-65131A	8'2"	2.5	12	48x30	.43	10.9	20A @ 125 V	SJT / 60°C	EN60320-2-2I	EN60320	NA	Black
IPC-65132A	9'10"	3	12	48x30	.43	10.9	20A @ 125 V	SJT / 60°C	EN60320-2-2I	EN60320	NA	Black

## Tri Rated Jumper Cords, 3 Conductor, Detachable UL/CSA/VDE

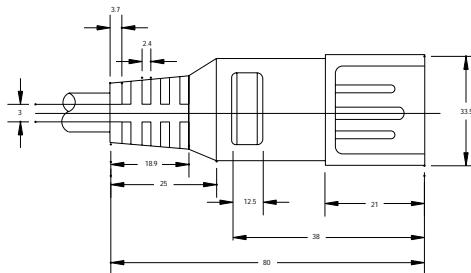
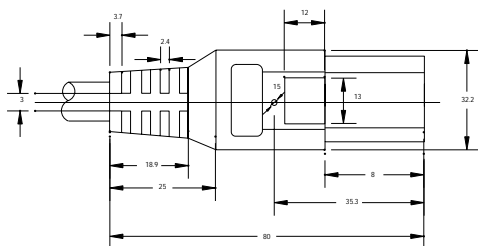

Detachable with an IEC-320-C19 to C20, 15 Amp



Part No.	Cord Length		Conductor AWG. MM	Nominal O.D.		Power Rating	Cord Type / Temp	Plug No.		Color Code	Jacket Color
	Ft	M		Inch	mm			Male	Fem.		
IPC-66237A	6'7"	2	14 / 1.5	.34	8.5	15/16A @ 250 V	SJT / H05VVF / 70°C	EN60320-2-2I	EN60320	CEE	Black
IPC-66238A	8'2"	2.5	14 / 1.5	.34	8.5	15/16A @ 250 V	SJT / H05VVF / 70°C	EN60320-2-2I	EN60320	CEE	Black
IPC-66239A	9'10"	3	14 / 1.5	.34	8.5	15/16A @ 250 V	SJT / H05VVF / 70°C	EN60320-2-2I	EN60320	CEE	Black

## Domestic Cordsets, 3 Conductor, Detachable

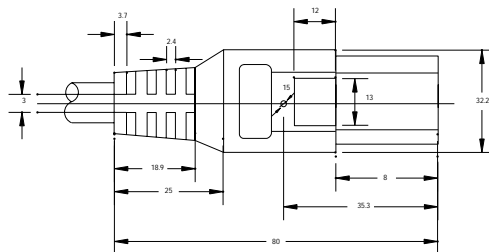
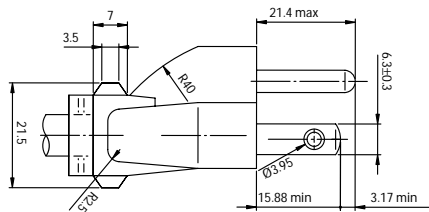

Detachable with an IEC-320-C19



Part No.	Cord Length		Conductor AWG. Strand	Nominal O.D.		Power Rating	Cord Type / Temp	Plug No.		Color Code	Jacket Color
	Ft	M		Inch	mm			Male	Fem.		
IPC-65133A	6'7"	2	14 / 41x30	.38	9.7	15A @ 125 V	SJT / 60°C	LP31	EN60320	NA	Black
IPC-65134A	8'2"	2.5	14 / 41x30	.38	9.7	15A @ 125 V	SJT / 60°C	LP31	EN60320	NA	Black
IPC-65135A	6'7"	2	12 / 41x30	.43	10.9	20A @ 125 V	SJT / 60°C	N5/20P	EN60320	NA	Black
IPC-65136A	8'2"	2.5	12 / 41x30	.43	10.9	20A @ 125 V	SJT / 60°C	N5/20P	EN60320	NA	Black

# Detachable Cordsets, 3 Conductor Detachable

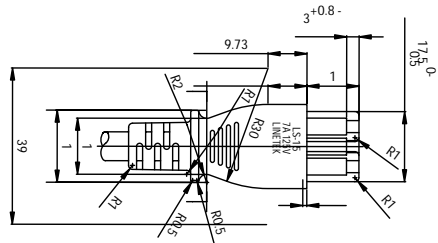
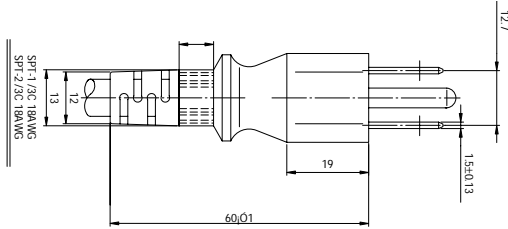

## Domestic Cordset with IEC-320, C5



Part No.	Cord Length		Conductor AWG. Strand	Nominal O.D.		Power Rating	Cord Type / Temp	Plug No.		Color Code	Jacket Color
	Ft	M		Inch	mm			Male	Fem.		
IPC-62518A	6'	1.83	18 41 X 34	.245	6.2	2.5A @ 125V	SVT / 60°C	LP30B	LS15	NA	Black
IPC-65120A	8'2"	2.5	18 41 x 34	.245	6.2	2.5A @ 125V	SVT / 60°C	LP30B	LS15	NA	Black

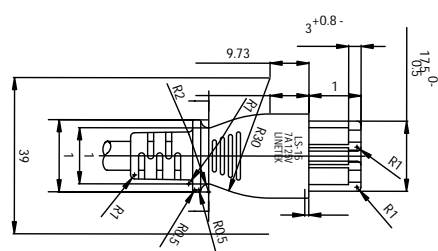
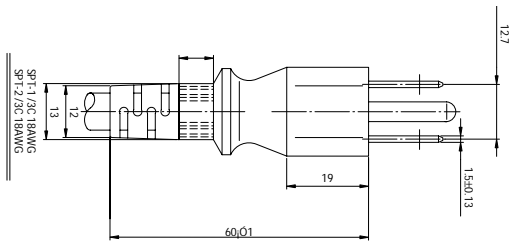

## Domestic Cordset with IEC-320, C5



Part No.	Cord Length		Conductor AWG. Strand	Nominal O.D.		Power Rating	Cord Type / Temp	Plug No.		Color Code	Jacket Color
	Ft	M		Inch	mm			Male	Fem.		
IPC-65121A	6'7"	2	18 41 x 34	.315	8.0	2.5A @ 125V	SJT / 60°C	LP30B	LS15	NA	Black
IPC-65122A	8'2"	2.5	18 41 x 34	.315	8.0	2.5A @ 125V	SJT / 60°C	LP30B	LS15	NA	Black



# Domestic Cordsets, 2 Conductor

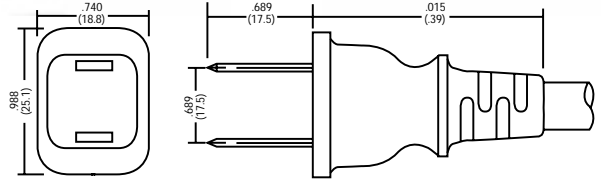

## Nondetachable

Conductors split 1 1/2", stripped 5/8"



Part No.	Cord Length		Conductor		Nominal O.D.		Power Rating	Cord Type / Temp	Plug No.		Color Code	Jacket Color
	Ft	M	AWG	Strand	Inch	mm			Male	Fem.		

## Unshielded

IPC-65012A	6'	1.83	18	41 x 34	.110 x .215	2.8 x 5.5	1250 Watts 10A-125V	SPT-1 / 60°C	LP-5W Polarized	---	NA	Black
IPC-65013A	9'	2.74	18	41 x 34	.110 x .215	2.8 x 5.5	1250 Watts 10A-125V	SPT-1 / 60°C	LP-5W Polarized	---	NA	Black
IPC-65059A	6'	1.83	18	41 x 34	.135 x .270	3.45 x 6.9	1250 Watts 10A-125V	SPT-2 / 60°C	LP-5W Polarized	---	NA	Black
IPC-65060A	8'	2.44	18	41 x 34	.135 x .270	3.45 x 6.9	1250 Watts 10A-125V	SPT-2 / 60°C	LP-5W Polarized	---	NA	Black
IPC-65061A	6'	1.83	16	65 x 34	.145 x .290	3.7 x 7.4	1625 Watts 13A-125V	SPT-2 / 60°C	LP-5W Polarized	---	NA	Black
IPC-65062A	8'	2.44	16	65 x 34	.145 x .290	3.7 x 7.4	1625 Watts 13A-125V	SPT-2 / 60°C	LP-5W Polarized	---	NA	Black

Note: All standard 2 conductor cords are supplied with polarized plug except IPC-65069A and IPC-65070A. If non-polarized plug is required, add -NO to end of P/N. Example: IPC-65012A-NO

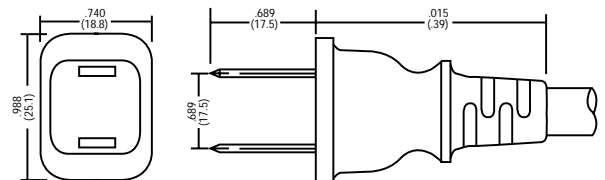

## Nondetachable



Part No.	Cord Length		Conductor		Nominal O.D.		Power Rating	Cord Type / Temp	Plug No.		Color Code	Jacket Color
	Ft	M	AWG	Strand	Inch	mm			Male	Fem.		

## Unshielded

IPC-65063A	6'	1.83	18	41 x 34	.244	6.2	1250 Watts 10A @ 125V	SVT / 60°C	LP-13W Polarized	---	NA	Black
IPC-65064A	8'	2.44	18	41 x 34	.244	6.2	1250 Watts 10A @ 125V	SVT / 60°C	LP-13W Polarized	---	NA	Black
IPC-65065A	6'	1.83	18	41 x 34	.288	7.3	1250 Watts 10A @ 125V	SJT / 60°C	LP-13W Polarized	---	NA	Black
IPC-65066A	8'	2.44	18	41 x 34	.288	7.3	1250 Watts 10A @ 125V	SJT / 60°C	LP-13W Polarized	---	NA	Black
IPC-65067A	6'	1.83	16	65 x 34	.315	8.0	1625 Watts 13A @ 125V	SJT / 60°C	LP-13W Polarized	---	NA	Black
IPC-65068A	8'	2.44	16	65 x 34	.315	8.0	1625 Watts 13A @ 125V	SJT / 60°C	LP-13W Polarized	---	NA	Black
IPC-65069A	6'	1.83	14	41 x 30	.360	9.2	1875 Watts 15A @ 125V	SJT / 60°C	LP-14	---	NA	Black
IPC-65070A	8'	2.44	14	41 x 30	.360	9.2	1875 Watts 15A @ 125V	SJT / 60°C	LP-14	---	NA	Black

Note: All standard 2 conductor cords are supplied with polarized plug except IPC-65069A and IPC-65070A. If non-polarized plug is required, add -NO to end of P/N. Example: IPC-65012A-NO



Call Toll Free: 1-800-341-3533

Telephone: (952) 835-2322

Fax: (952) 835-5080

# Domestic Cordsets, 2 Conductor Detachable

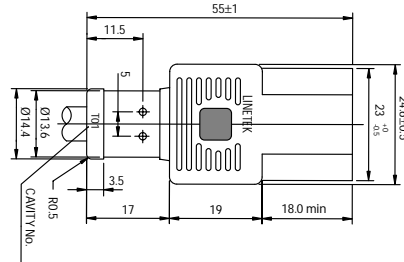
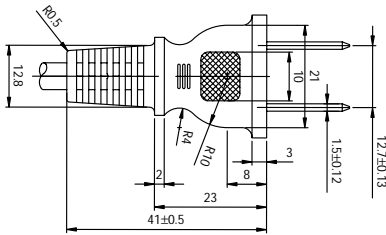

## Detachable with an IEC-320-C17



Part No.	Cord Length		Conductor AWG. Strand	Nominal O.D.		Power Rating	Cord Type / Temp	Plug No.		Color Code	Jacket Color
	Ft	M		Inch	mm			Male	Fem.		
IPC-61892B	6'	1.83	18 / 41x34	.244	6.2	10A @ 125V	SJT / 60°C	LP-13	LS-16	CEE	Black
IPC-65123A	8'2"	2.5	18 / 41x34	.244	6.2	10A @ 125V	SJT / 60°C	LP-13	LS-16	CEE	Black
IPC-62479A	9'10"	3	18 / 41x34	.244	6.2	10A @ 125V	SJT / 60°C	LP-13	LS-16	CEE	Black

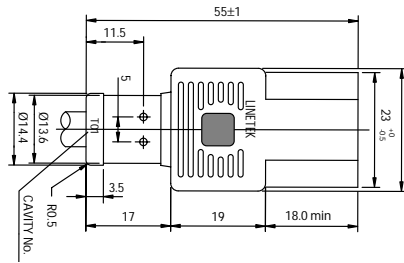
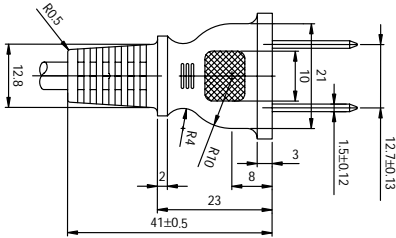

## Detachable with an IEC-320-C17



Part No.	Cord Length		Conductor AWG. Strand	Nominal O.D.		Power Rating	Cord Type / Temp	Plug No.		Color Code	Jacket Color
	Ft	M		Inch	mm			Male	Fem.		
IPC-65124A	6'7"	2	18 / 41x34	.288	7.3	10A @ 125V	SVT / 60°	LP-13	LS-16	CEE	Black
IPC-65125A	8'2"	2.5	18 / 41x34	.288	7.3	10A @ 125V	SVT / 60°	LP-13	LS-16	CEE	Black
IPC-65126A	9'10"	3	18 / 41x34	.288	7.3	10A @ 125V	SVT / 60°	LP-13	LS-16	CEE	Black

# Domestic Cordsets, 2 Conductor Detachable

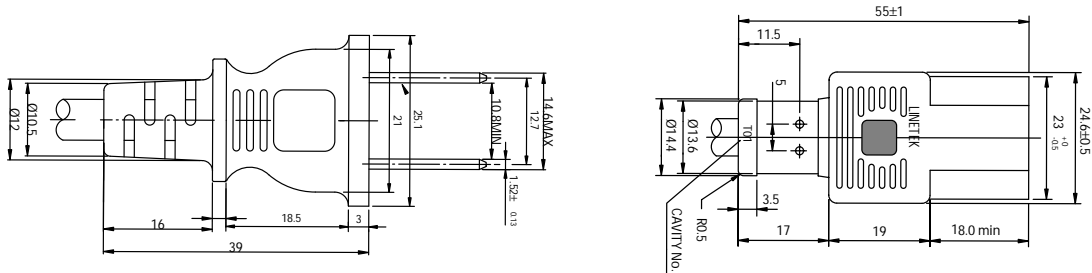

## Detachable with an IEC-320-C17



Part No.	Cord Length		Conductor AWG. Strand	Nominal O.D.		Power Rating	Cord Type / Temp	Plug No.		Color Code	Jacket Color
	Ft	M		Inch	mm			Male	Fem.		
IPC-65116A	6'7"	2	18 41x34	.135 x .280	3.5 x 7.1	10A @ 125V	SPT-2 / 60°C	LP-5W	LS16	NA	Black
IPC-65117A	8'2"	2.5	18 41x34	.135 x .280	3.5 x 7.1	10A @ 125V	SPT-2 / 60°C	LP-5W	LS16	NA	Black

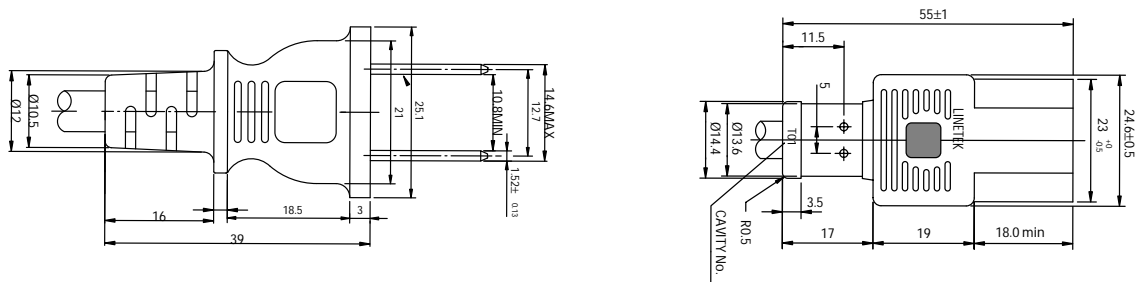

## Detachable with an IEC-320-C17



Part No.	Cord Length		Conductor AWG. Strand	Nominal O.D.		Power Rating	Cord Type / Temp	Plug No.		Color Code	Jacket Color
	Ft	M		Inch	mm			Male	Fem.		
IPC-65118A	6'7"	2	16 65x34	.135 x .280	3.5 x 7.1	10A @ 125V	SPT-2 / 60°C	LP-5W	LS16	NA	Black
IPC-65119A	8'2"	2.5	16 65x34	.135 x .280	3.5 x 7.1	10A @ 125V	SPT-2 / 60°C	LP-5W	LS16	NA	Black



# Domestic Cordsets, 2 Conductor Detachable

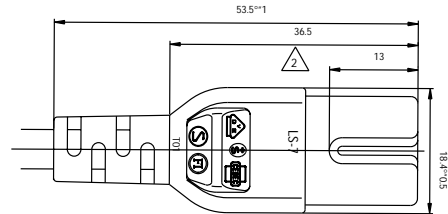
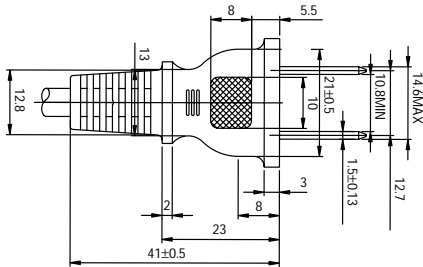

## Detachable with an IEC-320-C7



Part No.	Cord Length		Conductor		Nominal O.D.		Power Rating	Cord Type / Temp	Plug No.		Color Code	Jacket Color	
	Ft	M	AWG	Strand	Inch	mm			Male	Fem.			
IPC-62120D	6'	1.83	18	41 x 34	.135 x .280	3.45 x 6.9	7A @ 125V	SPT-2	60°C	LP5	LS7C	NA	Black
IPC-65145A	9'	2.7	18	41 x 34	.135 x .27	3.45 x 6.9	7A @ 125V	SPT-2	60°C	LP5	LS7C	NA	Black

Items also available but not pictured include:

1. Twist lock plugs
2. In-line switches
3. Nema 5/15R Receptacles